

## LD38S & LD38C

### HIGH-POWER MOUNTED EXTERIOR LED LINEAR SURFACE GRAZER



MOISTURE GUARD



LD38 is a high-power linear surface grazer offering superb continuous wall washing capabilities. Compact with a minimal design, lengths are made to measure up to 1350mm, with evenly maintained spacing across LEDs, resulting in no shadows. White, RGBW and Tunable White engines are available along with a choice of optics for wall washing or flood lighting, various mounting options and glare control accessories, offering great flexibility for a variety of applications. For additional glare control, LD38C can be specified and is supplied with an integrated anti-glare cowl.

## KEY FEATURES

- > Linear C1 engine featuring NICHIA LED delivering up to 3760lm
- > Custom lengths up to a maximum of 1350mm, with LED spacings of 50mm, 75mm, 100mm
- > Short pieces can be made interlinked to accommodate curves
- > Spacing is maintained across multiple lengths, ensuring no dark spots
- > Superb continuous wall washing capabilities with high efficiency optics and a choice of narrow to oval beam angles available
- > Aluminium extrusion, anodised to a thickness of 25 microns and available in a wide range of powder coated paint finishes
- > Range of glare control options including anti-glare louvre accessories or the LD38C for an integrated anti-glare cowl
- > Wide range of mounted or ground spike options for use in a variety of applications
- >  Contains our integral moisture guard (anti-wicking barrier), stopping water ingress from going up the cable into the product from incorrect IP-rated connections
- > Switched, 0-10V, Casambi, DMX, DALI and Mains dimmable drivers available

## DIMENSIONS

Dimensions in mm

For fixing dimensions please go to page 5.

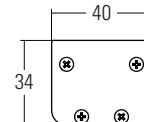
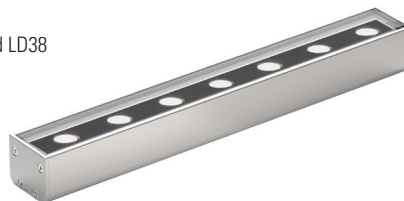

LD38S  
Standard LD38

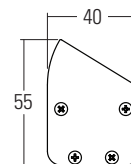

LD38C  
Integrated linear anti-glare cowl, supplied with special end caps to further reduce glare from the sides



## WHITE LED ENGINE SPECIFICATION

Engine	 Linear C1		
Beam angles	12°, 31°, 48°, 12° x 36°, 15° x 60°		
LED manufacturer	NICHIA		
Colour temperature	2200K / 2700K / 3000K / 4000K / 5000K		
Current / [Rated Output]	350mA [1.2W]	500mA [1.7W]	700mA [2.4W]
Typical LED Circuit wattage	1.1W	1.6W	2.3W
Delivered lumens (L <sub>100</sub> )* per metre			
50mm spacing	2160	2820	3760
75mm spacing	1436	1875	2500
100mm spacing	1080	1410	1880
Delivered lm/Circuit W**	90	83	78
Typical LED Source wattage	1W	1.5W	2.1W
Source LED lm (per LED)	133	187	206
Source lm/W	136	129	98
Forward voltage (V <sub>100</sub> ) per LED	2.8V	2.9V	3V
CRI	93		
Colour consistency	2SCDM		
Peak intensity per m	20,806 cd		
LOR	0.91		
TM30	RF93   RG99		
UGR rating ('downlight' mounted)	15.7	16.6	17.6
BUG rating ('uplight' mounted)	B0-U4-G0		
LED lifetime	L90B5 at 90,000hrs		
Applications			

Data is based on LD38-C1-700-LW30-NB

\*Lumen output data applies to all colour temperatures

\*\*LED wattage includes losses associated with using a 90% efficient driver

## MECHANICAL

Ambient temperature	-20° to 50° (350mA-700mA)
Glass	4mm thick low iron glass
Materials	Anodised aluminium body and end caps to 25 microns
IP rating	IP67
Wiring	In-series constant current wiring, pre-wired at a length of 2m which can be specified up to 10m at extra cost

## ENVIRONMENTAL

TM65	Available on request
TM66	2.2

## AVAILABLE FINISHES

LD38 has been designed for extreme environments, so only high quality materials and finishes are used to ensure long lasting reliability. All parts are silver anodised to a minimum thickness of 25 microns which offers high protection in all external environments. RAL powder coat paint finishes are also available, allowing the LD38 to blend into the surrounding architecture.



**SILVER ANODISED**



**ANTIQUÉ BRONZE**



**SATIN ANTIQUÉ BRASS**



**SATIN BRASS**



**BLACK**  
(RAL 9005)

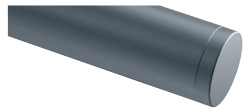

**ANTHRACITE GREY**  
(RAL 7016)



**WHITE**  
(RAL 9016)



**RAL COLOURS**

## DIMENSIONS & FIXING OPTIONS

*Dimensions in mm*

### /BSM Bracket side mounting

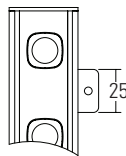
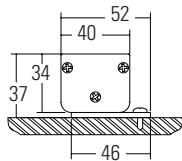
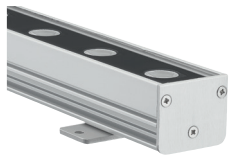

### /ABM Surface adjustable bracket mounting

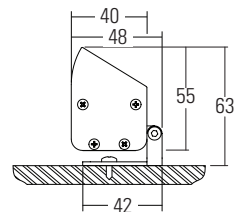
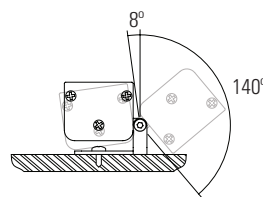
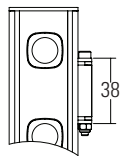
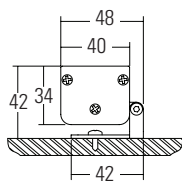

### /AWB-50 Adjustable wall bracket 50mm

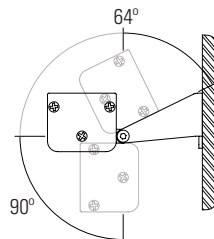
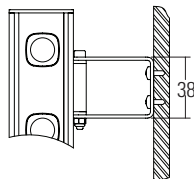
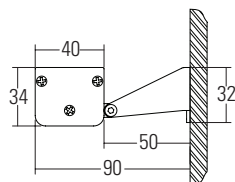

**/AWB-300 Adjustable wall bracket 300mm**  
For custom dimensions please contact us

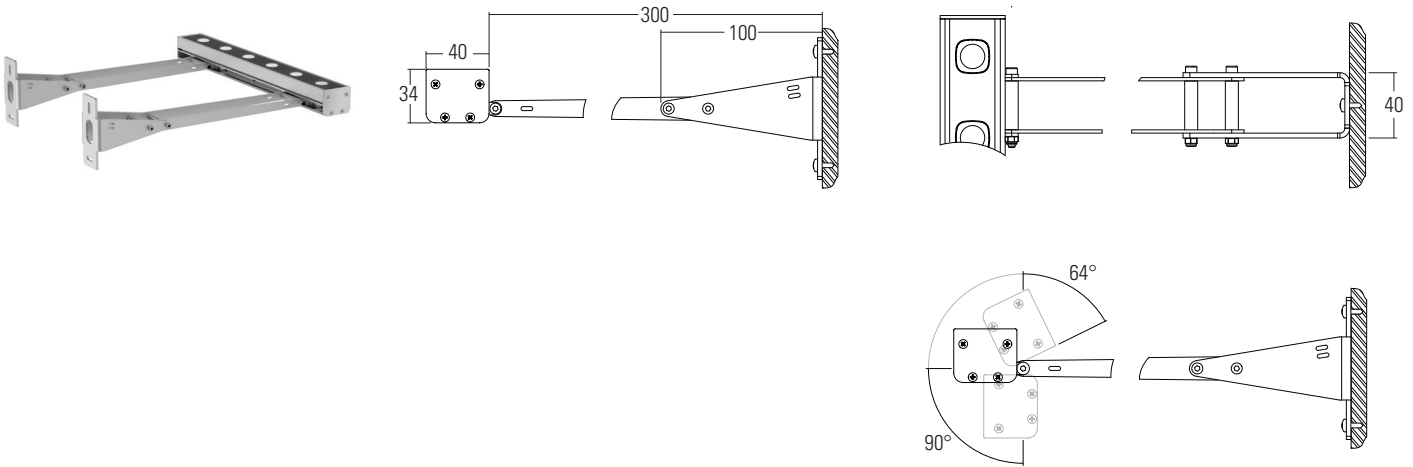

**/GS Ground spike**

The ground spike accessory enables the use of the LD38 as an alternative to conventional spotlights. It offers linear lighting for a range of landscape and garden lighting effects such as lighting hedge rows, walls, or around trees with multiple short pieces used to create a curve. It can be specified with wider LED spacing to suit the budget or light output needed.

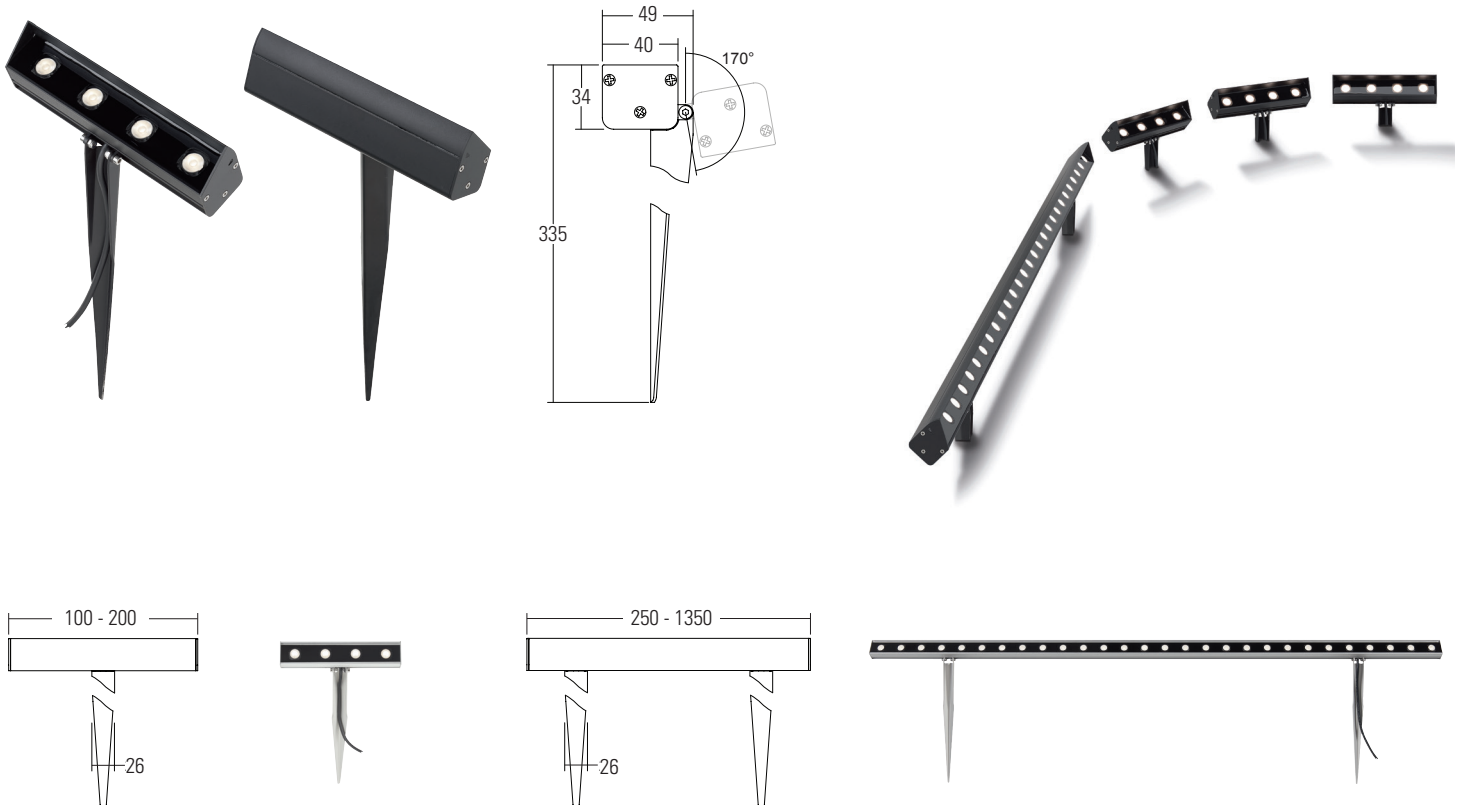

## MADE TO MEASURE

Custom made lengths allow the designer to specify the exact length required. Spacing of 50mm, 75mm and 100mm are maintained across multiple lengths, so no dark spots are created.

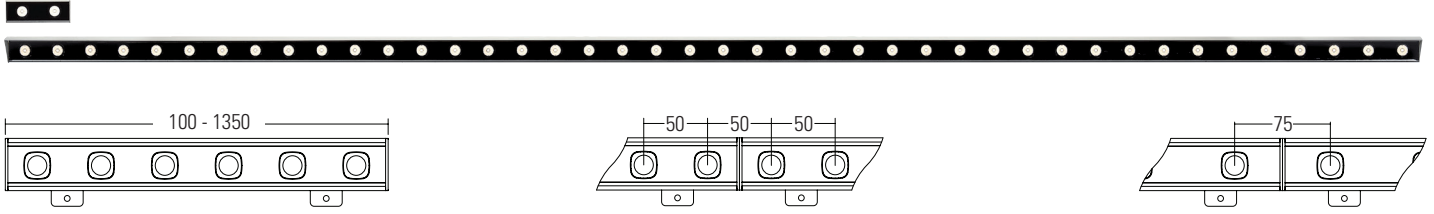

## BEAM ANGLE OPTIONS

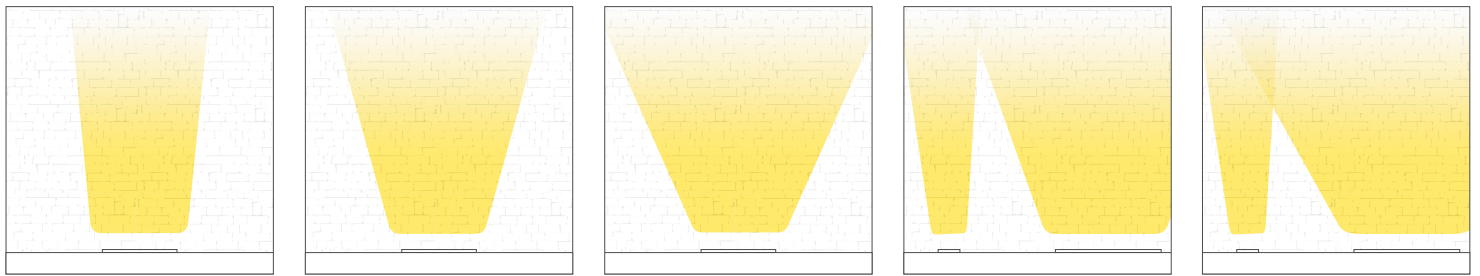

**/NB**  
Narrow Beam  
12°

**/MB**  
Medium Beam  
31°

**/WB**  
Wide Beam  
48°

**/OB**  
Oval Beam  
12° x 36°

**/EOB**  
Extra Oval Beam  
15° x 60°

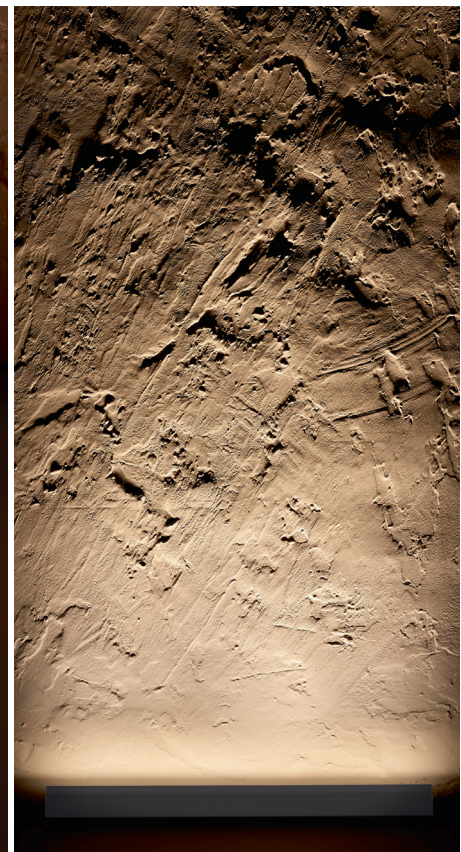

## APPLICATION & MOUNTING OPTION GUIDE

LD38 is incredibly versatile so can be used to illuminate an entire external project in applied in various scenarios. From high-power wall grazing, window reveals, floodlighting and landscape illumination, there is a fixing accessory and specification to suit. Made to measure lengths allow effects to be created for particular details. If the required fixing or accessory is not featured please get in touch.

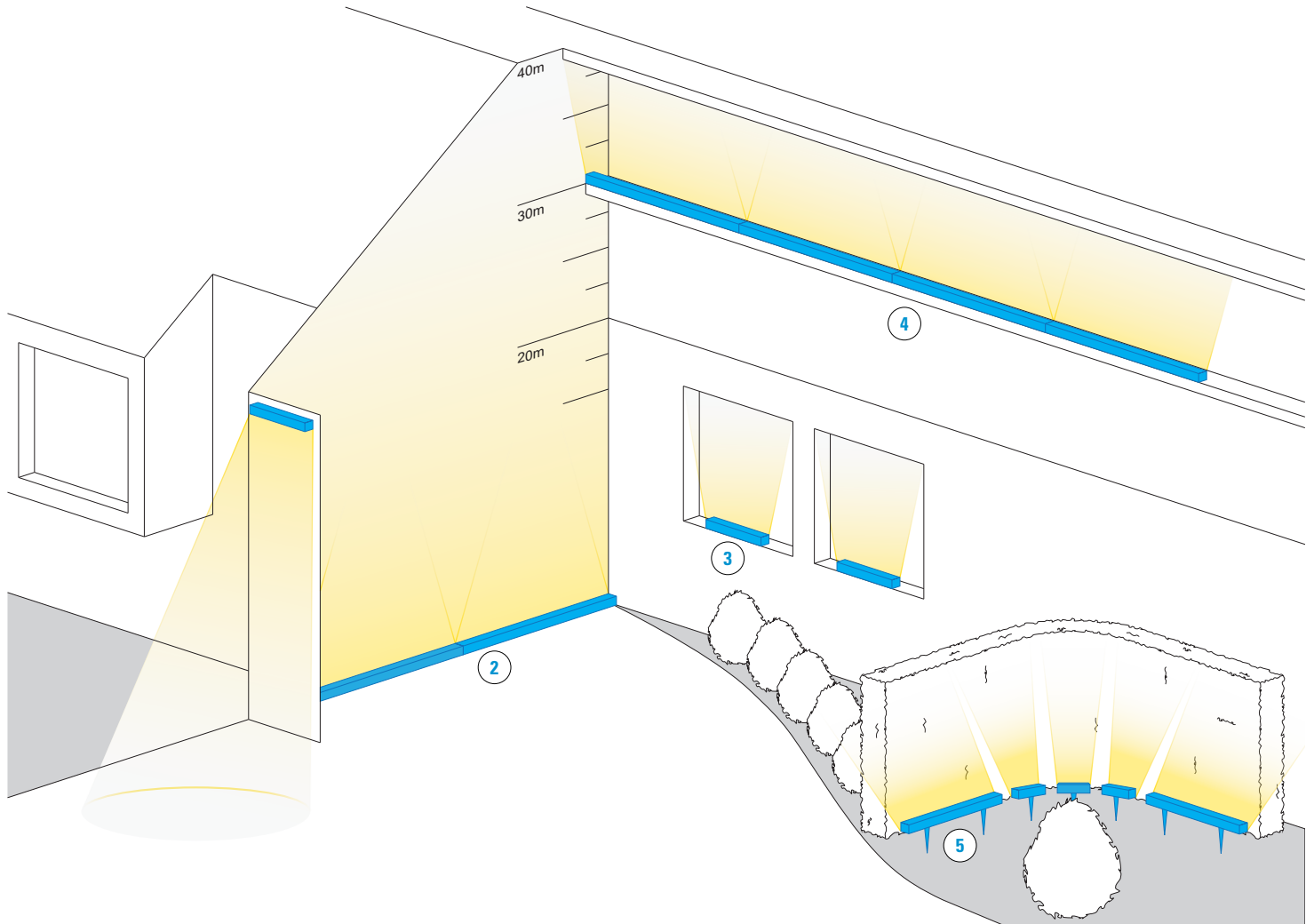

### MOUNTING OPTIONS:

1

/AWB-50



/AWB-300

2

/AWB-50



/AWB-300

3

/ABM



/BSM

4

/ABM



/BSM

5

/GS



## LINKED APPLICATIONS

LD38 can be specified in short interlinked sections for curved applications such as trees or columns. Two channels can be used to provide up to 28 LEDs at 500mA or 26 at 700mA.

### Design advice

This section provides advisory module quantities and lengths to ensure drivers are used to their full potential. Custom module and link lengths can be specified.

LED spacing	Module length	No. of modules
350mA / 500mA		
50mm spacing	200mm (4 LEDs)	Maximum of 28 LEDs on 2 channels, resulting in 7 modules of 4 LEDs
75mm spacing	300mm (4 LEDs)	
700mA		
50mm spacing	200mm (4 LEDs)	There is a maximum of 26 LEDs on 2 channels, resulting in 6 modules of 4 LEDs
75mm spacing	300mm (4 LEDs)	

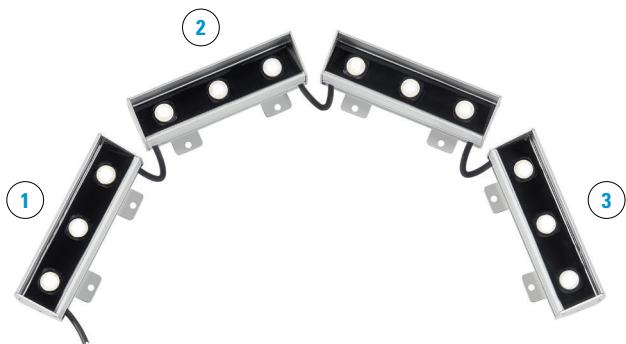
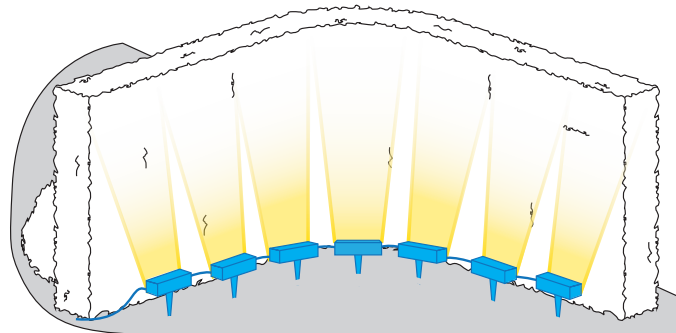

Note: Standard linked cable length - 100mm.

### Specifying linked LD38

Using the order codes and options table on the last page, specify the fitting output, LED colour, LED spacing, beam, finish and mounting method, then use the guide below to specify the individual modules. See example code and image below.

### Example:

2025mm required = 1 x 300mm linked starter, 5 x 300mm linked middle, 1 x 225mm linked end

	Feed length	Module length	Linked length	Quantity
1 Linked starter -	2m	150mm	100mm	1
2 Linked middle -		150mm	100mm	2
3 Linked end -			150mm	1

The following is an example code of how the code is broken down if an exact length is specified.

### Specification:

LD38-C1-700 / LW30 / 50 / OB / White / AWB-50 / IP67 / CO

## ACCESSORIES

### Anti-glare louvre

Please note the /GL is supplied as standard, available in black only and used to prevent glare from the viewers looking towards the surface being lit. The reversed GLF orientation is useful for applications where the LD38 is placed outside on a window ledge, to prevent glare from the perspective of the viewers inside the building looking out.



**/GL**  
Standard orientation of louvre

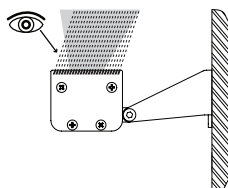

**/GLF**  
Orientation available on request

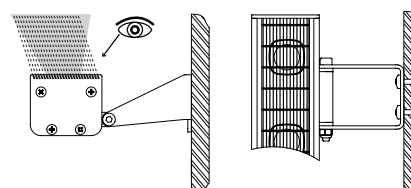

## ORDER CODES & OPTIONS

Example: LD38C-C1-700 / LW30 / 50 / OB / Silver / AWB-50 / GL / 500mm

Light Engine & Drive Current	LED Colour	LED Spacing	Beam Angle	Finish	Fixing	Accessory	Length (Up to 1350mm)
LD38C - LD38S -							

### WHITE LED ENGINES



#### LINEAR C1 ENGINE

1.2W LED at 350mA	LD38C-C1-350 LD38S-C1-350	Super Warm White (2200K)	/LW22	50mm	/50	12° Narrow spot	/NB			
1.7W LED at 500mA	LD38C-C1-500 LD38S-C1-500	Extra Warm White (2700K)	/LW27	75mm	/75	31° Medium	/MB	Paint Finish Silver	/AWB-50	/GL
2.4W LED at 700mA	LD38C-C1-700 LD38S-C1-700	Warm White (3000K)	/LW30	100mm	/100	48° Wide	/WB	Paint Finish Antique Bronze	/AWB-300	/GLF
		White (4000K) - on request	/LW40			12° x 36° Oval Beam	/OB	Paint Finish Satin Antique Brass	/ABM	
		Cool White (5000K)	/LW50			15° x 60° Extra Oval Beam	/EOB	Paint Finish Satin Brass	/BSM	
		Red	/LR					Paint Finish Black (RAL 9005)	/GS	
		Green	/GR					Paint Finish Anthracite Grey (RAL 7016)		
		Blue	/LB					Paint Finish White (RAL 9016)		
		Amber	/LA					Paint Finish RAL		

### DYNAMIC LED ENGINES (BY SPECIAL REQUEST)



#### RGBW

3.5W LED at 350mA	LD38C- RGBW-350 LD38S- RGBW-350	75mm	/75	60° Wide	/WB
5W LED at 500mA	LD38C- RGBW-500 LD38S- RGBW-500				

#### Drivers

Use with 350mA, 500mA & 700mA constant current LED drivers  
We have a range of dimmable LED drivers including DMX and DALI compatible.  
Please see the downloads section on our website.